



# CHE100W Series Application Note V10 March 2013

---

## ISOLATED DC-DC CONVERTER CHE100W SERIES APPLICATION NOTE



### Approved By:

Department	Approved By	Checked By	Written By
Research and Development Department	Enoch	Jacky	Jason
Quality Assurance Department	Jack	Benny	



# CHE100W Series

## Application Note V10 March 2013

---

### Contents

1. Introduction .....	3
2. DC-DC Converter Features.....	3
3. Electrical Block Diagram .....	3
4. Technical Specifications.....	4
5. Main Features and Functions.....	8
5.1 Operating Temperature Range .....	8
5.2 Output Voltage Adjustment.....	8
5.3 Overcurrent Protection .....	8
5.4 Output Overvoltage Protection .....	8
5.6 Remote ON/OFF .....	8
5.7 UVLO (Undervoltage Lock Out).....	8
5.8 Overtemperature Protection .....	8
6. Applications.....	8
6.1 Recommended Layout, PCB Footprint and Soldering Information.....	8
6.2 Convection Requirements for Cooling .....	9
6.3 Thermal Considerations .....	9
6.4 Power Derating.....	9
6.5 Half Brick Heat Sinks:.....	11
6.6 Efficiency VS. Load .....	12
6.7 Test Set-Up.....	14
6.8 Output Voltage Adjustment.....	14
6.9 Output Remote Sensing .....	15
6.10 Output Ripple and Noise.....	15
6.11 Output Capacitance.....	16
7. Safety & EMC.....	16
7.1 Input Fusing and Safety Considerations .....	16
7.2 EMC Considerations.....	16
8. Part Number .....	22
9. Mechanical Specifications .....	22
9.1 Mechanical Outline Diagrams.....	22



# CHE100W Series

## Application Note V10 March 2013

### 1. Introduction

The CHE100W series offers 100 watts of output power with high power density in an industry standard half-brick package. The CHE series has wide (4:1) input voltage ranges of 9-36 and 18-75VDC and provides a precisely regulated output. This series has features such as high efficiency, 1500VDC isolation and a case operating temperature range of  $-40^{\circ}\text{C}$  to  $105^{\circ}\text{C}$ . The modules are fully protected against input UVLO (under voltage lock out), output short circuit, output overvoltage and overtemperature conditions. Furthermore, the standard control functions include remote on/off and output voltage trimming. All models are highly suited to telecommunications, distributed power architectures, battery operated equipment, industrial, and mobile equipment applications.

### 2. DC-DC Converter Features

- 100W Isolated Output
- Efficiency (at full load) up to 93%
- Regulated Output
- Fixed Switching Frequency
- Input Under Voltage Lockout Protection
- Over Current Protection
- Remote ON/OFF
- Continuous Short Circuit Protection
- Industry Standard Half-Brick Package
- Fully Isolated to 1500VDC

### 3. Electrical Block Diagram

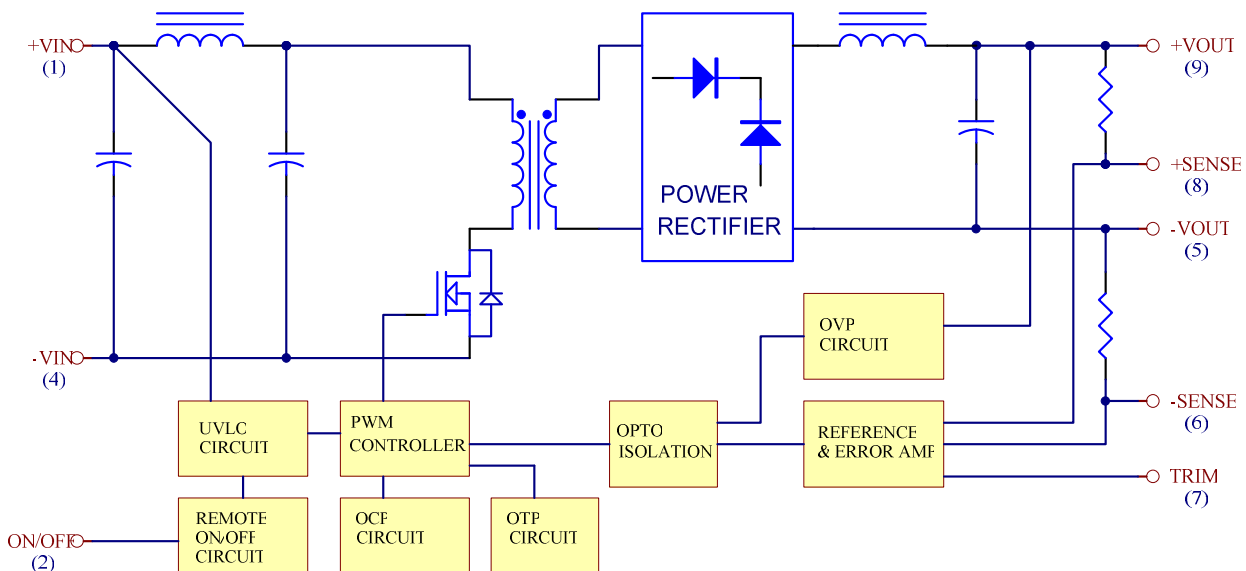

Electrical Block Diagram



# CHE100W Series

## Application Note V10 March 2013

### 4. Technical Specifications

(All specifications are typical at nominal input, full load at 25°C unless otherwise noted.)

#### ABSOLUTE MAXIMUM RATINGS

PARAMETER	NOTES and CONDITIONS	Device	Min.	Typical	Max.	Units
Input Voltage						
Continuous		24SXX	9	24	36	V <sub>dc</sub>
		48SXX	18	48	75	
Transient	100ms	24SXX			50	V <sub>dc</sub>
		48SXX			100	
Operating Case Temperature		All	-40		105	°C
Storage Temperature		All	-55		105	°C
Isolation Voltage	1 minute; input/output, input/case, output/case	All	1500			V <sub>dc</sub>

#### INPUT CHARACTERISTICS

Operating Input Voltage		24SXX	9	24	36	V <sub>dc</sub>
		48SXX	18	48	75	
Input Under Voltage Lockout						
Turn-On Voltage Threshold		24SXX	8	8.5	8.8	V <sub>dc</sub>
		48SXX	16.5	17	17.5	
Turn-Off Voltage Threshold		24SXX	7.7	8	8.3	V <sub>dc</sub>
		48SXX	15.5	16	16.5	
Lockout Hysteresis Voltage		24SXX		0.6		V <sub>dc</sub>
		48SXX		0.9		
Maximum Input Current	100% Load, V <sub>in</sub> =9V for 24SXX 100% Load, V <sub>in</sub> =18V for 48SXX	24SXX		13		A
		48SXX		6.3		
No-Load Input Current		24S3V3		200		mA
		24S05				
		24S12				
		24S15				
		24S24		100		
		24S48				
		48S3V3		130		
		48S05				
		48S12		100		
		48S15				
48S24						
48S48						
Inrush Current (I <sup>2</sup> t)		All			0.1	A <sup>2</sup> s
Input Reflected Ripple Current	P-P thru 12uH inductor, 5Hz to 20MHz	All		30		mA



# CHE100W Series

## Application Note V10 March 2013

### OUTPUT CHARACTERISTICS

PARAMETER	NOTES and CONDITIONS	Device	Min.	Typical	Max.	Units
Output Voltage Set Point	$V_{in} = \text{Nominal } V_{in}, I_o = I_{o\_max}, T_c = 25^\circ\text{C}$	$V_o = 3.3 V_{dc}$	3.2505	3.3	3.3495	$V_{dc}$
		$V_o = 5.0 V_{dc}$	4.925	5	5.075	
		$V_o = 12 V_{dc}$	11.82	12	12.18	
		$V_o = 15 V_{dc}$	14.775	15	15.225	
		$V_o = 24 V_{dc}$	23.64	24	24.36	
		$V_o = 48 V_{dc}$	47.28	48	48.72	
Output Voltage Regulation						
Load Regulation	$I_o = I_{o\_min}$ to $I_{o\_max}$	All			$\pm 0.2$	%
Line Regulation	$V_{in} = \text{low line to high line}$	All			$\pm 0.2$	%
Temperature Coefficient	$T_c = -40^\circ\text{C}$ to $105^\circ\text{C}$	All			$\pm 0.03$	%/ $^\circ\text{C}$
Output Voltage Ripple and Noise (5Hz to 20MHz bandwidth)						
Peak-to-Peak	Full load, 10uF tantalum and 1.0uF ceramic capacitors	$V_o = 3.3V$ & $5.0V$			100	mV
		$V_o = 12V$ & $15V$			150	
	Full load, 10uF Aluminum and 1.0uF ceramic capacitors	$V_o = 24V$			240	
		$V_o = 48V$			480	
RMS	Full load, 10uF solid tantalum and 1.0uF ceramic capacitors	$V_o = 3.3V$ & $5.0V$			40	mV
		$V_o = 12V$ & $15V$			60	
	Full load, 10uF Aluminum and 1.0uF ceramic capacitors	$V_o = 24V$			100	
		$V_o = 48V$			200	
Operating Output Current Range		$V_o = 3.3 V_{dc}$	0		25	A
		$V_o = 5.0 V_{dc}$	0		20	
		$V_o = 12 V_{dc}$	0		8.4	
		$V_o = 15 V_{dc}$	0		6.7	
		$V_o = 24 V_{dc}$	0		4.2	
		$V_o = 48 V_{dc}$	0		2.1	
Output DC Current Limit Inception	Output Voltage=90% Nominal Output Voltage		105	125	140	%
Maximum Output Capacitance	Full load (resistive)	$I_o = 25A$			25000	uF
		$I_o = 20$			20000	
		$I_o = 8.4A$			8400	
		$I_o = 6.7A$			6700	
		$I_o = 4.2A$			4200	
		$I_o = 2.1A$			2100	

### DYNAMIC CHARACTERISTICS

PARAMETER	NOTES and CONDITIONS	Device	Min.	Typical	Max.	Units
Output Voltage Current Transient	1A/us					
Step Change in Output Current	75% to 100% of $I_{o\_max}$				$\pm 5$	%
Setting Time (within 1% $V_{out}$ nominal)	$d_i/d_r = 0.1A/us$				500	us
Turn-On Delay and Rise Time						
Turn-On Delay Time, From On/Off Control	$V_{on/off}$ to $10\%V_{o\_set}$	All		10		ms
Turn-On Delay Time, From Input	$V_{in\_min}$ to $10\%V_{o\_set}$	All		10		ms
Output Voltage Rise Time	$10\%V_{o\_set}$ to $90\%V_{o\_set}$	All		10		ms



# CHE100W Series

## Application Note V10 March 2013

### EFFICIENCY

100% Load	Vin = 12Vdc	24S3V3	85.5		%
		24S05	88.5		
		24S12	90		
		24S15	89.5		
		24S24	88.5		
		24S48	89.5		
	Vin = 24Vdc	24S3V3	87		
		24S05	89.5		
		24S12	90.5		
		24S15	90.5		
		24S24	89		
		24S48	88.5		
	Vin = 24Vdc	48S3V3	87.5		
		48S05	91.5		
		48S12	92.5		
		48S15	91.5		
		48S24	91		
		48S48	91.5		
	Vin = 48Vdc	48S3V3	88		
		48S05	92		
		48S12	93		
		48S15	92.5		
		48S24	91		
		48S48	90.5		

### ISOLATION CHARACTERISTICS

Isolation Voltage	1 minute; input/output, input/case, output/case			1500	V <sub>dc</sub>
Isolation Resistance			10		MΩ
Isolation Capacitance				1000	pF

### FEATURE CHARACTERISTICS

PARAMETER	NOTES and CONDITIONS	Device	Min.	Typical	Max.	Units
Switching Frequency				250		KHz
ON/OFF Control, Positive Remote On/Off logic						
Logic Low (Module Off)	V <sub>on/off</sub> at I <sub>on/off</sub> =1.0mA				1.8	V
Logic High (Module On)	V <sub>on/off</sub> at I <sub>on/off</sub> =0.0uA		3.5 or Open Circuit		75	V
ON/OFF Control, Negative Remote On/Off logic						
Logic High (Module Off)	V <sub>on/off</sub> at I <sub>on/off</sub> =0.0uA		3.5 or Open Circuit		75	V
Logic Low (Module On)	V <sub>on/off</sub> at I <sub>on/off</sub> =1.0mA				1.8	V



## CHE100W Series Application Note V10 March 2013

ON/OFF Current (for both remote on/off logic)	$I_{on/off}$ at $V_{on/off}=0.0V$			0.3	1	mA
Leakage Current (for both remote on/off logic)	Logic High, $V_{on/off}=15V$				30	uA
Off Converter Input Current	Shutdown input idle current			4	10	mA
Output Voltage Trim Range	$P_{out}=\text{max rated power}$		-10		+10	%
Output Over Voltage Protection			115	125	140	%
Over-Temperature Shutdown				105		°C

### GENERAL SPECIFICATIONS

MTBF	$I_o=100\%$ of $I_{o\_max}$ ; $T_a=25^\circ\text{C}$ per MIL-HDBK-217F	XXS05		0.75		M hours
		Others		0.88		
Weight				95		grams



# CHE100W Series

## Application Note V10 March 2013

### 5. Main Features and Functions

#### 5.1 Operating Temperature Range

The CHE100W series converters can be operated within a wide case temperature range of  $-40^{\circ}\text{C}$  to  $105^{\circ}\text{C}$ . Consideration must be given to the derating curves when ascertaining maximum power that can be drawn from the converter. The maximum power drawn from open half brick models is influenced by usual factors, such as:

- Input voltage range
- Output load current
- Forced air or natural convection

#### 5.2 Output Voltage Adjustment

Section 6.8 describes in detail how to trim the output voltage with respect to its set point. The output voltage on all models is adjustable within the range of  $+10\%$  to  $-10\%$ .

#### 5.3 Overcurrent Protection

All models have internal overcurrent and continuous short circuit protection. The unit operates normally once the fault condition is removed. At the point of current limit inception, the converter will go into hiccup mode protection.

#### 5.4 Output Overvoltage Protection

The output overvoltage protection consists of circuitry that internally limits the output voltage. If more accurate output over voltage protection is required then an external circuit can be used via the remote on/off pin.

#### 5.6 Remote ON/OFF

The CHE100W series allows the user to switch the module on and off electronically with the remote on/off feature. All models are available in "positive logic" and "negative logic" (optional) versions. The converter turns on if the remote ON/OFF pin is high ( $>3.5\text{Vdc}$  or open circuit). Setting the pin low ( $<1.8\text{Vdc}$ ) will turn the converter off. The signal level of the remote on/off input is defined with respect to ground. If not using the remote on/off pin, leave the pin open (converter will be on). Models with part number suffix "N" are the "negative logic" remote ON/OFF version. The unit turns off if the remote ON/OFF pin is high ( $>3.5\text{Vdc}$  or open circuit). The converter turns on if the ON/OFF pin input is low ( $<1.8\text{Vdc}$ ). Note that the converter is off by default.

#### 5.7 UVLO (Undervoltage Lock Out)

Input under voltage lockout is standard on the CHE100W unit. The unit will shut down when the input voltage drops below a threshold, and the unit will operate when the input voltage goes above the upper threshold.

#### 5.8 Overtemperature Protection

These modules have an overtemperature protection circuit to safeguard against thermal damage. Shutdown occurs with the maximum case reference temperature is exceeded. The module will restart when the case temperature falls below overtemperature shutdown threshold.

### 6. Applications

#### 6.1 Recommended Layout, PCB Footprint and Soldering Information

The system designer or end user must ensure that metal and other components in the vicinity of the converter meet the spacing requirements for which the system is approved. Low resistance and inductance PCB layout traces are the norm and should be used where possible. Due consideration must also be given to proper low impedance tracks between power module, input and output grounds. The recommended soldering profile and PCB layout are shown below.

Lead Free Wave Soldering Profile

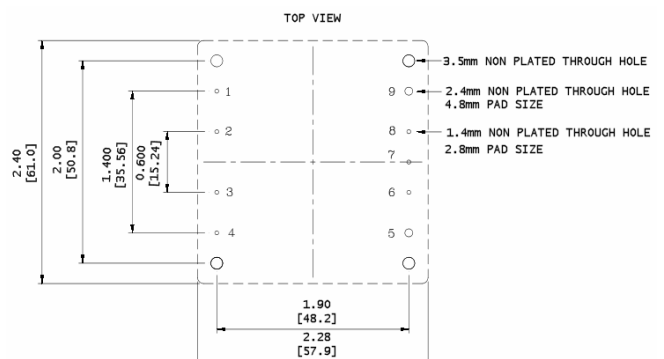
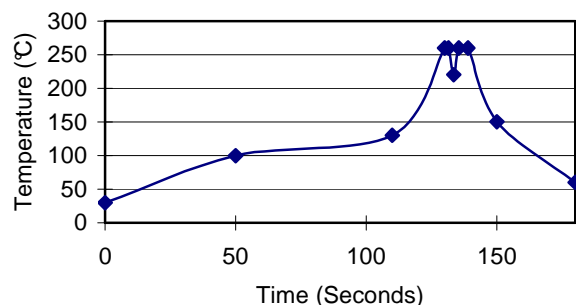





# CHE100W Series

## Application Note V10 March 2013

### 6.2 Convection Requirements for Cooling

To predict the approximate cooling needed for the half brick module, refer to the power derating curves in section 6.4. These derating curves are approximations of the ambient temperatures and airflows required to keep the power module temperature below its maximum rating. Once the module is assembled in the actual system, the module's temperature should be monitored to ensure it does not exceed 100°C as measured at the center of the top of the case (thus verifying proper cooling).

### 6.3 Thermal Considerations

The power module operates in a variety of thermal environments; however, sufficient cooling should be provided to help ensure reliable operation of the unit. Heat is removed by conduction, convection, and radiation to the surrounding environment. The test data is presented in section 6.4. The power output of the module should not be allowed to exceed rated power ( $V_{o\_set} \times I_{o\_max}$ ).

### 6.4 Power Derating

The operating case temperature range of CHE100W series is -40°C to +105°C. When operating the CHE100W series, proper derating or cooling is needed. The maximum case temperature under any operating condition should not exceed 105°C.

#### Example:

What is the minimum airflow necessary for a CHE100W-48S12 operating at nominal line voltage, an output current of 8.4A, and a maximum ambient temperature of 50°C?

#### Solution:

#### Given:

$$V_{in}=48V_{dc}, V_o=12V_{dc}, I_o=8.4A$$

#### Determine Power dissipation ( $P_d$ ):

$$P_d = P_i - P_o = P_o(1-\eta)/\eta$$
$$P_d = 12V \times 8.4A \times (1-0.93)/0.93 = 7.59Watts$$

#### Determine airflow:

$$\text{Given: } P_d = 7.59W \text{ and } T_a = 50^\circ C$$

#### Check Power Derating curve:

Minimum airflow = 100 ft./min.

#### Verify:

$$\text{Maximum temperature rise is}$$
$$\Delta T = P_d \times R_{ca} = 7.59W \times 6.21 = 47.13^\circ C.$$
$$\text{Maximum case temperature is}$$
$$T_c = T_a + \Delta T = 97.13^\circ C < 105^\circ C.$$

#### Where:

The  $R_{ca}$  is thermal resistance from case to ambient environment.

$T_a$  is ambient temperature and  $T_c$  is case temperature.

#### Example (with heatsink M-C091):

What is the minimum airflow necessary for a CHE100W-48S12 operating at nominal line voltage, an output current of 8.4A, and a maximum ambient temperature of 60°C .

#### Solution:

#### Given:

$$V_{in}=48V_{dc}, V_o=12V_{dc}, I_o=8.4A$$

#### Determine Power dissipation ( $P_d$ ):

$$P_d = P_i - P_o = P_o(1-\eta)/\eta$$
$$P_d = 12 \times 8.4 \times (1-0.93)/0.93 = 7.59Watts$$

#### Determine airflow:

$$\text{Given: } P_d = 7.59W \text{ and } T_a = 60^\circ C$$

#### Check above Power derating curve:

Natural Convection

#### Verify:

$$\text{Maximum temperature rise is}$$
$$\Delta T = P_d \times R_{ca} = 7.59W \times 4.7 = 35.67^\circ C$$
$$\text{Maximum case temperature is}$$
$$T_c = T_a + \Delta T = 95.67^\circ C < 105^\circ C$$

#### Where:

The  $R_{ca}$  is thermal resistance from case to ambient environment.

$T_a$  is ambient temperature and  $T_c$  is case temperature.



# CHE100W Series

## Application Note V10 March 2013

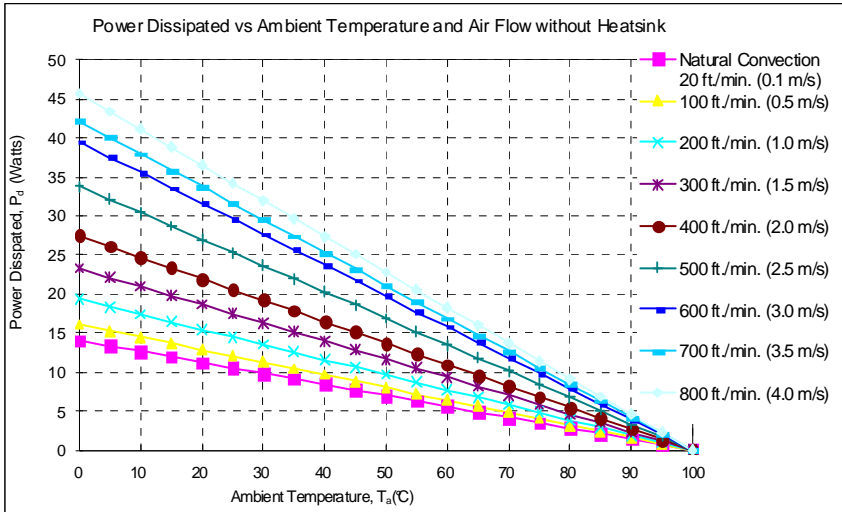

AIR FLOW RATE	TYPICAL $R_{ca}$
Natural convection	7.12°C/W
20ft./min. (0.1m/s)	7.12°C/W
100 ft./min. (0.5m/s)	6.21°C/W
200 ft./min. (1.0m/s)	5.17°C/W
300 ft./min. (1.5m/s)	4.29°C/W
400 ft./min. (2.0m/s)	3.64°C/W
500 ft./min. (2.5m/s)	2.96°C/W
600 ft./min. (3.0m/s)	2.53°C/W
700 ft./min. (3.5m/s)	2.37°C/W
800 ft./min. (4.0m/s)	2.19°C/W

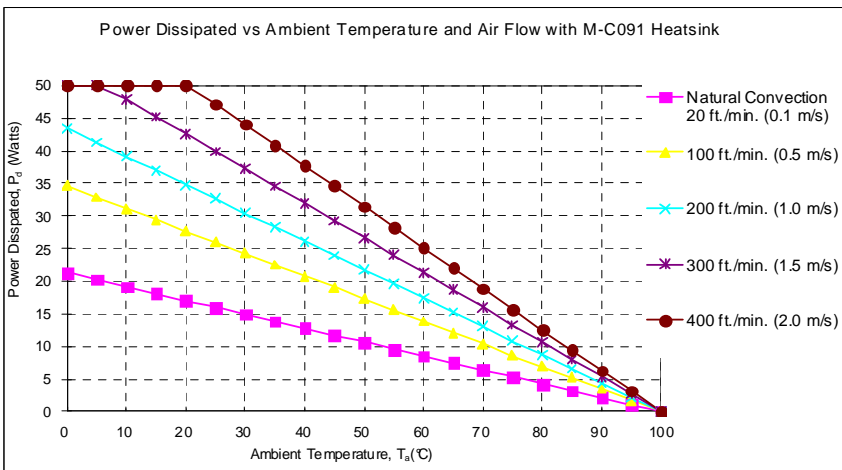

AIR FLOW RATE	TYPICAL $R_{ca}$
Natural convection	4.70°C/W
20ft./min. (0.1m/s)	4.70°C/W
100 ft./min. (0.5m/s)	2.89°C/W
200 ft./min. (1.0m/s)	2.30°C/W
300 ft./min. (1.5m/s)	1.88°C/W
400 ft./min. (2.0m/s)	1.59°C/W

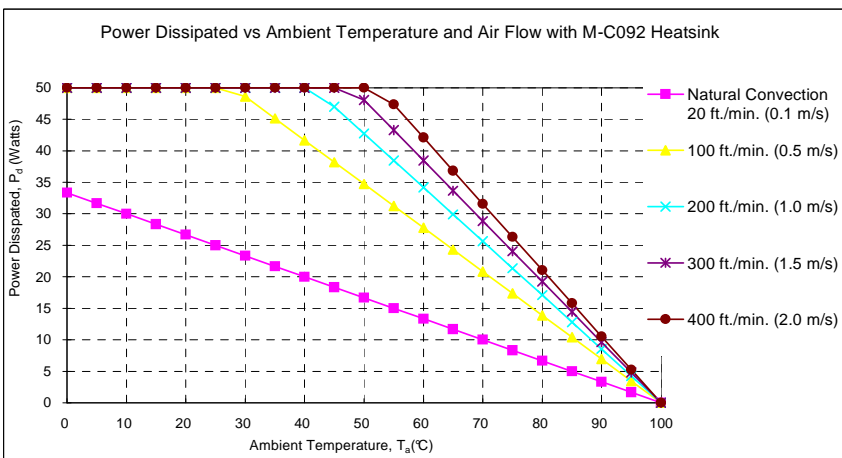

AIR FLOW RATE	TYPICAL $R_{ca}$
Natural convection	3.00°C/W
20ft./min. (0.1m/s)	3.00°C/W
100 ft./min. (0.5m/s)	1.44°C/W
200 ft./min. (1.0m/s)	1.17°C/W
300 ft./min. (1.5m/s)	1.04°C/W
400 ft./min. (2.0m/s)	0.95°C/W



# CHE100W Series

## Application Note V10 March 2013

### 6.5 Half Brick Heat Sinks:

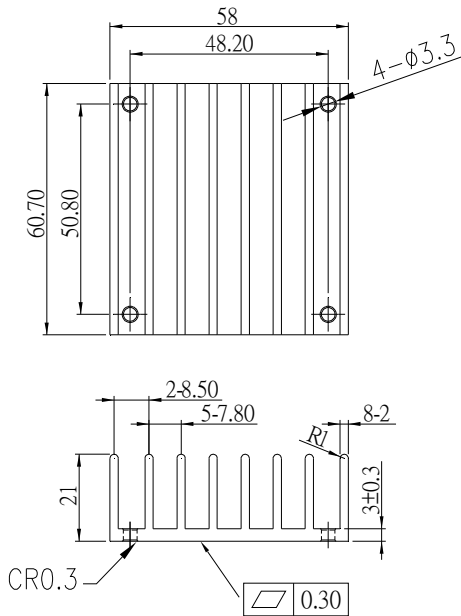

**M-C308 (G6620400201)**  
Longitudinal Heat Sink

**Rca:**  
 3.90°C/W (typ.), natural convection  
 1.74°C/W (typ.), at 100LFM  
 1.33°C/W (typ.), at 200LFM  
 1.12°C/W (typ.), at 300LFM  
 0.97°C/W (typ.), at 400LFM

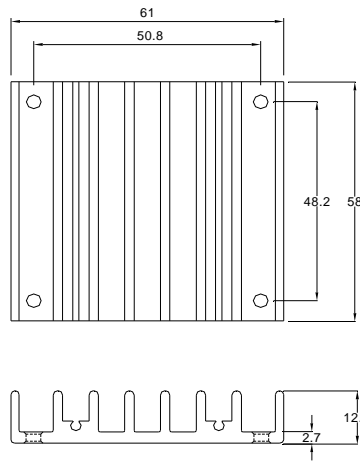

**M-C091 (G6610120402)**  
Transverse Heat Sink

**Rca:**  
 4.70°C/W (typ.), natural convection  
 2.89°C/W (typ.), at 100LFM  
 2.30°C/W (typ.), at 200LFM  
 1.88°C/W (typ.), at 300LFM  
 1.59°C/W (typ.), at 400LFM

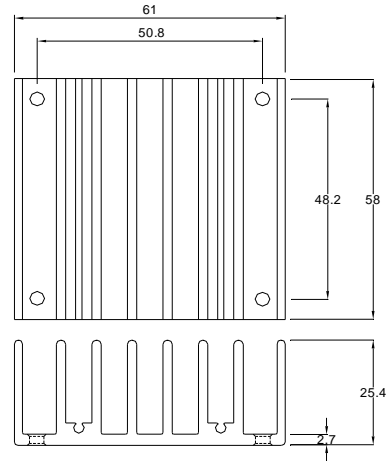

**M-C092 (G6610130402)**  
Transverse Heat Sink

**Rca:**  
 3.00°C/W (typ.), natural convection  
 1.44°C/W (typ.), at 100LFM  
 1.17°C/W (typ.), at 200LFM  
 1.04°C/W (typ.), at 300LFM  
 0.95°C/W (typ.), at 400LFM

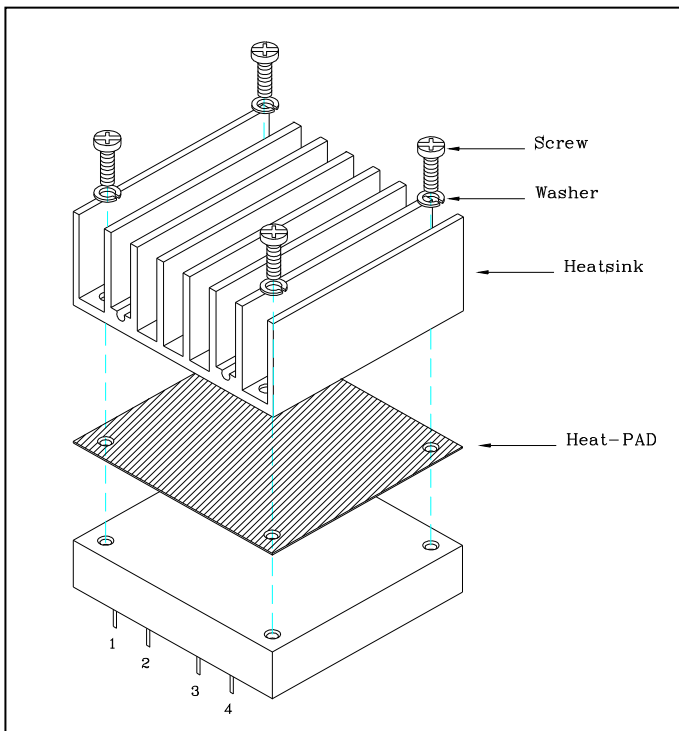

**THERMAL PAD:** SZ 56.9\*60\*0.25 mm  
(G6135041091 )  
**SCREW:** SMP+SW M3\*8L  
(G75A1300322 )



# CHE100W Series

## Application Note V10 March 2013

### 6.6 Efficiency VS. Load

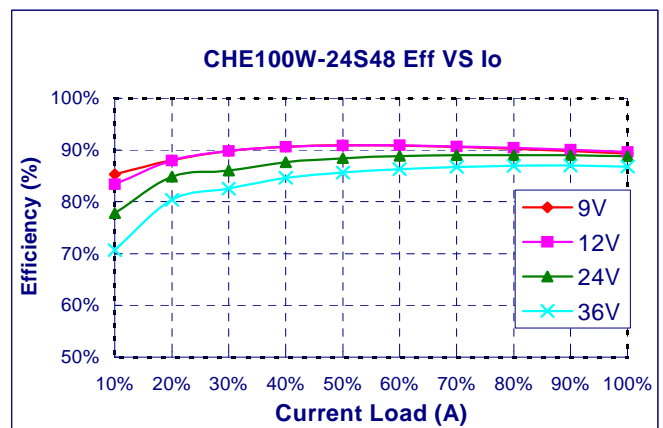
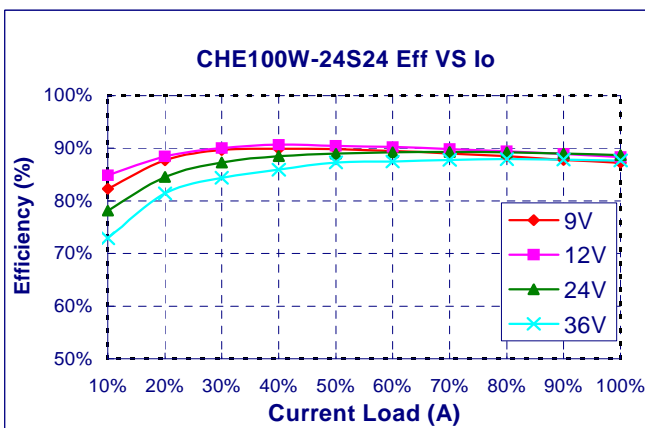
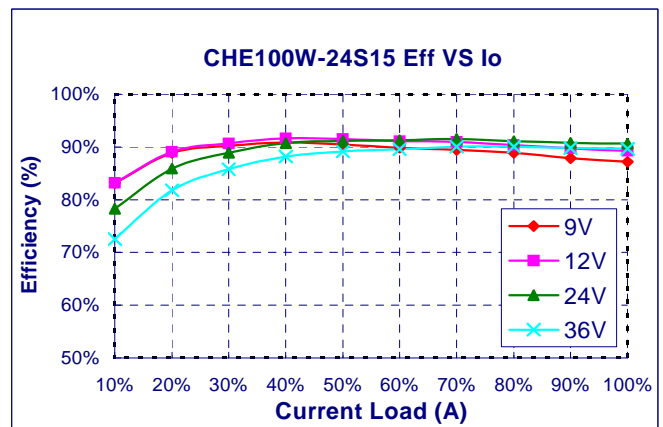
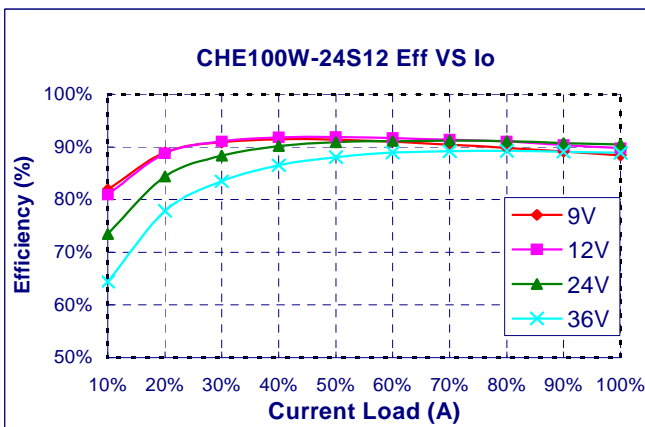
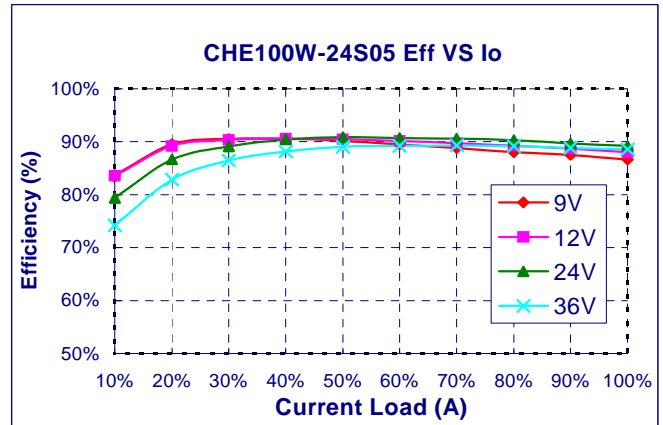
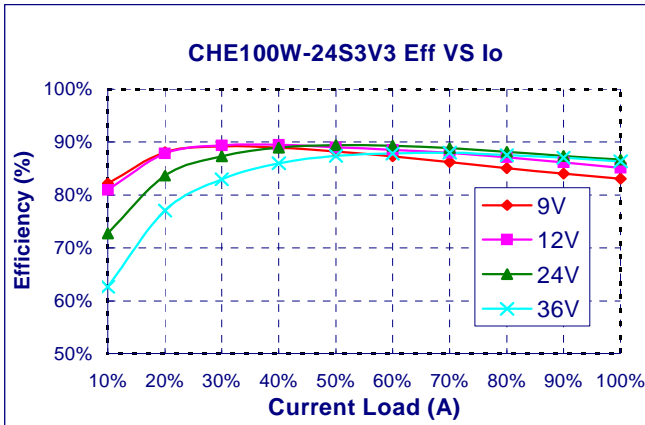



# CHE100W Series

## Application Note V10 March 2013

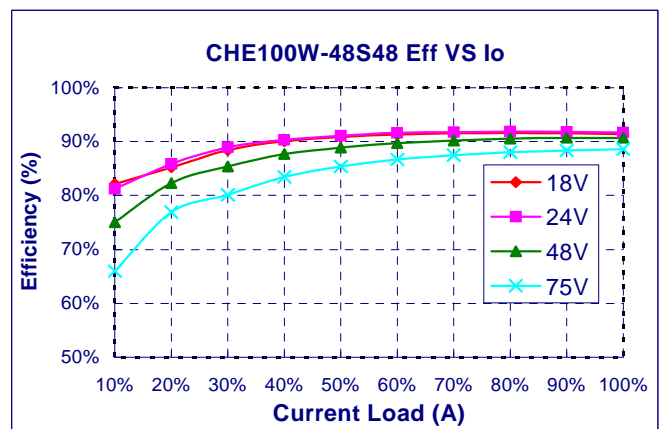
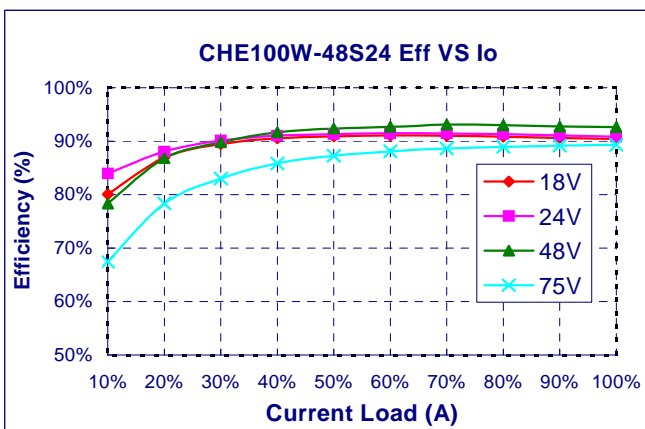
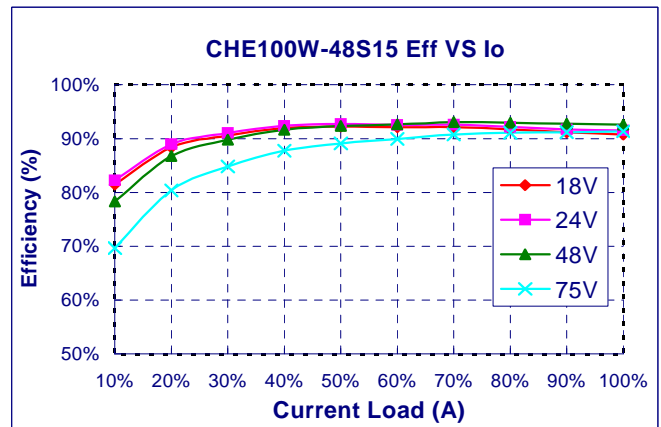
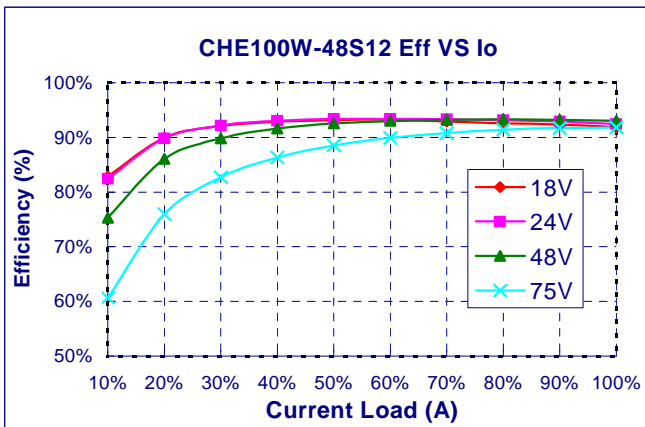
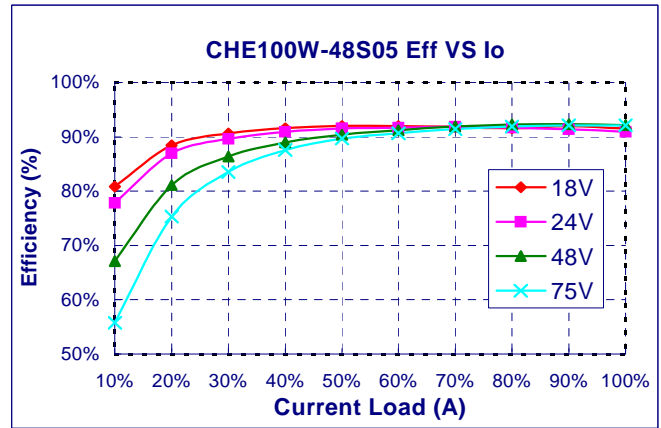
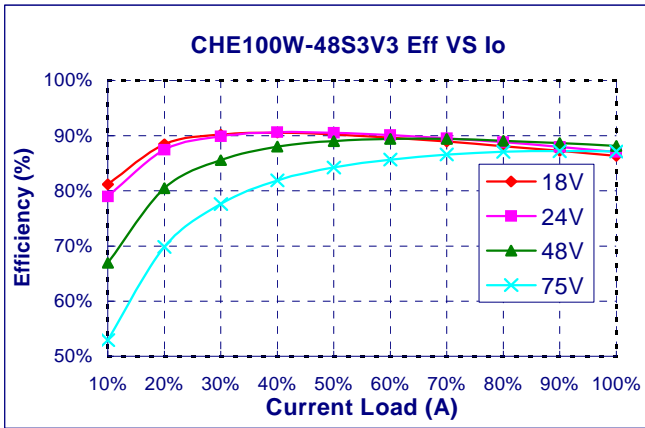

**Note:** The Y-axis (Efficiency) shows values from 55% to 90% EXCEPT on models 24S15, 48S12, 48S15 and 48S24. Because these models may operate at efficiencies of 90% or higher, the Y-axis (Efficiency) shows values from 60% to 100%.



# CHE100W Series

## Application Note V10 March 2013

### 6.7 Test Set-Up

The basic test set-up to measure parameters such as efficiency and load regulation is shown below. When testing the modules under any transient conditions please ensure that the transient response of the source is sufficient to power the equipment under test. We can calculate:

- Efficiency
- Load regulation and line regulation.

The value of efficiency is defined as:

$$\eta = \frac{V_o \times I_o}{V_{in} \times I_{in}} \times 100\%$$

Where:

$V_o$  is output voltage,  
 $I_o$  is output current,  
 $V_{in}$  is input voltage,  
 $I_{in}$  is input current.

The value of load regulation is defined as:

$$Load.reg = \frac{V_{FL} - V_{NL}}{V_{NL}} \times 100\%$$

Where:

$V_{FL}$  is the output voltage at full load  
 $V_{NL}$  is the output voltage at no load

The value of line regulation is defined as:

$$Line.reg = \frac{V_{HL} - V_{LL}}{V_{LL}} \times 100\%$$

Where:

$V_{HL}$  is the output voltage of maximum input voltage at full load.  $V_{LL}$  is the output voltage of minimum input voltage at full load.

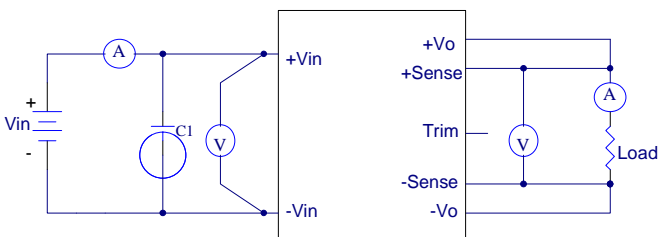

CHE100W Series Test Setup

### 6.8 Output Voltage Adjustment

Output may be externally trimmed ( $\pm 10\%$ ) with a fixed resistor or an external trimpot as shown (optional). Model specific formulas for calculating trim resistors are available upon request as a separate document.

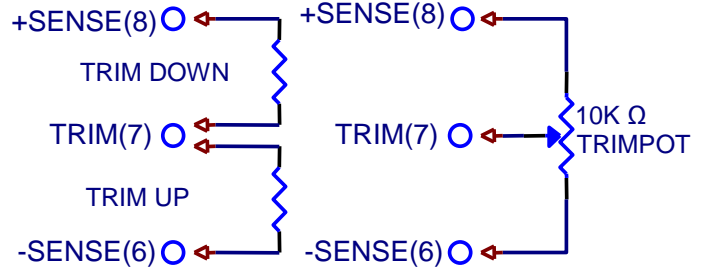

In order to trim the voltage up or down, one needs to connect the trim resistor either between the trim pin and  $-V_o$  for trim-up or between trim pin and  $+V_o$  for trim-down. The output voltage trim range is  $\pm 10\%$ . This is shown:

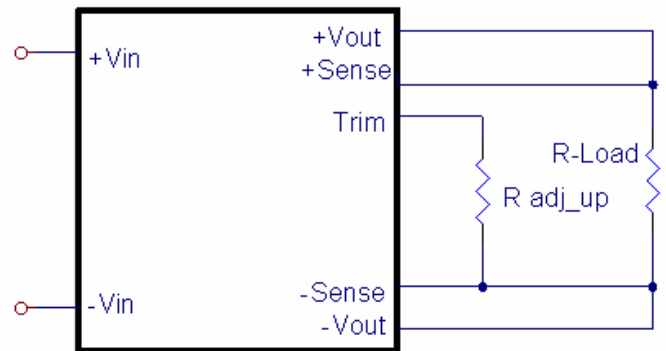

Trim-up Voltage Setup

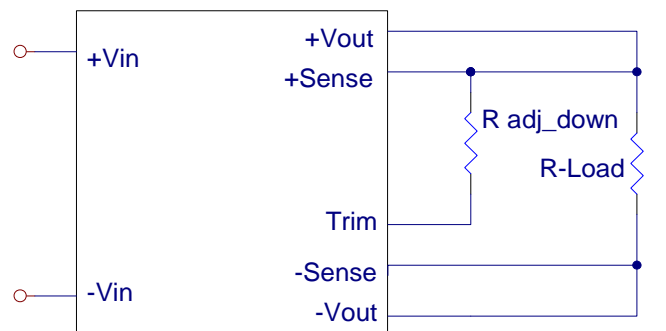

Trim-down Voltage Setup

$V_{out}$ (V)	R1 (K $\Omega$ )	R2 (K $\Omega$ )	R3 (K $\Omega$ )	$V_r$ (V)	$V_f$ (V)
3.3V	3.0	12	4.3	1.24	0.46
5V	2.32	3.3	0	2.5	0
12V	9.1	51	5.1	2.5	0.46
15V	12	56	8.25	2.5	0.46
24V	20	100	7.5	2.5	0.46
48V	36	270	5.1	2.5	0.46

Trim Resistor Values

The value of  $R_{trim\_up}$  defined as:



# CHE100W Series

## Application Note V10 March 2013

$$R_{trim\_up} = \left( \frac{R_1(V_r - V_f(\frac{R_2}{R_2 + R_3}))}{V_o - V_{o\_nom}} \right) - \frac{R_2 R_3}{R_2 + R_3} \text{ (K}\Omega\text{)}$$

Where:

- $R_{trim\_up}$  is the external resistor in K $\Omega$ .
- $V_{o\_nom}$  is the nominal output voltage.
- $V_o$  is the desired output voltage.
- $R_1, R_2, R_3$  and  $V_r$  are internal components.

For example, to trim-up the output voltage of 12V module (CHE100W-48S12) by 5% to 12.6V,  $R_{trim\_up}$  is calculated as follows:

$$\begin{aligned} V_o - V_{o\_nom} &= 12.6 - 12 = 0.6V \\ R_1 &= 9.1 \text{ K}\Omega, R_2 = 51 \text{ K}\Omega, R_3 = 5.1 \text{ K}\Omega, \\ V_r &= 2.5 \text{ V}, V_f = 0.46 \text{ V} \end{aligned}$$

$$R_{trim\_up} = \frac{18.944}{0.6} - 4.636 = 26.94 \text{ (K}\Omega\text{)}$$

The value of  $R_{trim\_down}$  defined as:

$$R_{trim\_down} = \frac{R_1 \times (V_o - V_r)}{V_{o\_nom} - V_o} - R_2 \text{ (K}\Omega\text{)}$$

Where:

- $R_{trim\_down}$  is the external resistor in K $\Omega$ .
- $V_{o\_nom}$  is the nominal output voltage.
- $V_o$  is the desired output voltage.
- $R_1, R_2, R_3$  and  $V_r$  are internal components.

For example: to trim-down the output voltage of 12V module (CHE100W-48S12) by 5% to 11.4V,  $R_{trim\_down}$  is calculated as follows:

$$\begin{aligned} V_{o\_nom} - V_o &= 12 - 11.4 = 0.6 \text{ V} \\ R_1 &= 9.1 \text{ K}\Omega, R_2 = 51 \text{ K}\Omega, V_r = 2.5 \text{ V} \end{aligned}$$

$$R_{trim\_down} = \frac{9.1 \times (11.4 - 2.5)}{0.6} - 51 = 83.98 \text{ (K}\Omega\text{)}$$

### 6.9 Output Remote Sensing

The CHE100W series converters have the capability to remotely sense both lines of its output. This feature moves the effective output voltage regulation point from the output of the unit to the point of connection of the remote sense pins. This feature automatically adjusts the real output voltage of the CHE100W series

in order to compensate for voltage drops in distribution and maintain a regulated voltage at the point of load. The remote-sense voltage range is:

$$[(+V_{out}) - (-V_{out})] - [(+Sense) - (-Sense)] \leq$$

10% of  $V_{o\_nominal}$

If the remote sense feature is not to be used, the sense pins should be connected locally. The +Sense pin should be connected to the + $V_{out}$  pin at the module and the -Sense pin should be connected to the - $V_{out}$  pin at the module. This is shown in the schematic below.

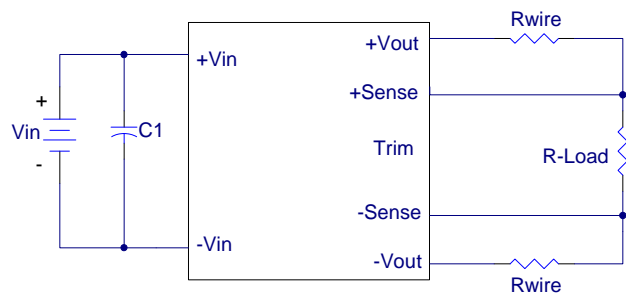

**Note:** Although the output voltage can be varied (increased or decreased) by both remote sense and trim, the maximum variation for the output voltage is the larger of the two values not the sum of the values. The output power delivered by the module is defined as the voltage at the output terminals multiplied by the output current. Using remote sense and trim can cause the output voltage to increase and consequently increase the power output of the module if output current remains unchanged. Always ensure that the output power of the module remains at or below the maximum rated power. Also be aware that if  $V_{o\_set}$  is below nominal value,  $P_{out,max}$  will also decrease accordingly because  $I_{o,max}$  is an absolute limit. Thus,  $P_{out,max} = V_{o,set} \times I_{o,max}$  is also an absolute limit.

### 6.10 Output Ripple and Noise

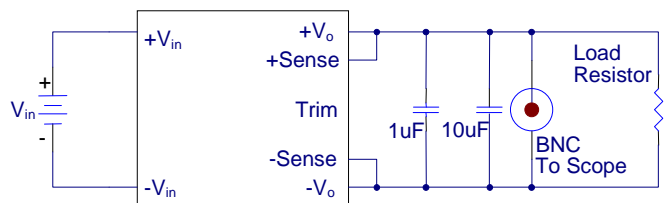

$V_o=24$  &  $48V$  Output ripple and noise is measured with 1.0uF ceramic and 10uF/100V KMF Aluminum capacitors across the output. Other  $V_o$  Output ripple and noise is measured with 1.0uF ceramic and 10uF solid tantalum capacitors across the output.





# CHE100W Series

## Application Note V10 March 2013

### 6.11 Output Capacitance

The CHE100W series converters provide unconditional stability with or without external capacitors. For good transient response, low ESR output capacitors should be located close to the point of load. PCB design emphasizes low resistance and

inductance tracks in consideration of high current applications. Output capacitors with their associated ESR values have an impact on loop stability and bandwidth. Cincon's converters are designed to work with load capacitance up to 1000uF per amp.

## 7. Safety & EMC

### 7.1 Input Fusing and Safety Considerations

The CHE100W series converters have no internal fuse. In order to achieve maximum safety and system protection, always use an input line fuse. We recommended a 20A time delay fuse for 24V<sub>in</sub> models, and 10A for 48V<sub>in</sub> models. It is recommended that the circuit have a transient voltage suppressor diode (TVS) across the input terminal to protect the unit against surge or spike voltage and input reverse voltage (as shown).

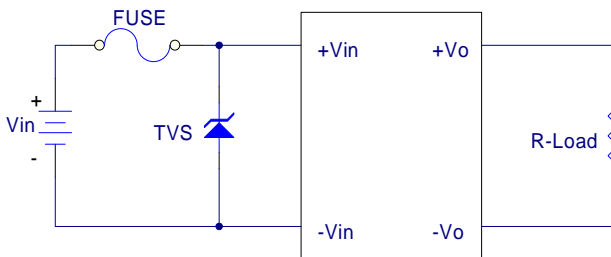

### 7.2 EMC Considerations

EMI Test standard: EN55022 Class A and Class B Conducted Emission  
 Test Condition: Input Voltage: Nominal, Output Load: Full Load

(1) EMI and conducted noise meet EN55022 Class A:

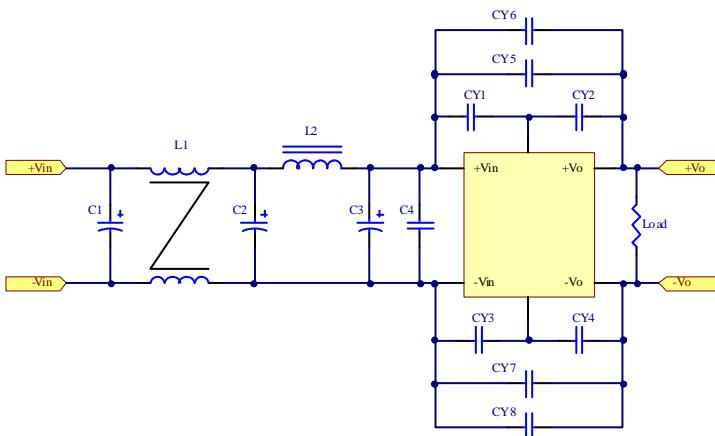





# CHE100W Series

## Application Note V10 March 2013

Model No.	C1	C2	C3	C4	CY1	CY2	CY3	CY4	CY5	CY6	CY7	L1	L2
CHE100W-24S33	--	220u/63V	220u/63V	2200pF	--	--	2200pF	2200pF	2200pF	--	2200pF	--	3.4uH
CHE100W-24S05	--	220u/63V	220u/63V	2200pF	--	--	2200pF	2200pF	2200pF	--	2200pF	--	3.4uH
CHE100W-24S12	--	220u/63V	220u/63V	2200pF	--	--	2200pF	2200pF	2200pF	--	2200pF	--	3.4uH
CHE100W-24S15	--	220u/63V	220u/63V	2200pF	--	--	2200pF	2200pF	2200pF	--	2200pF	--	3.4uH
CHE100W-24S24	--	220u/63V	220u/63V	2200pF	--	--	2200pF	2200pF	2200pF	--	2200pF	--	3.4uH
CHE100W-24S48	--	220u/63V	220u/63V	2200pF	--	--	2200pF	2200pF	2200pF	--	2200pF	--	3.4uH
CHE100W-48S33	--	82u/100V	82u/100V	2200pF	--	--	2200pF	2200pF	2200pF	--	2200pF	--	3.4uH
CHE100W-48S05	--	82u/100V	82u/100V	2200pF	--	--	2200pF	2200pF	2200pF	--	2200pF	--	3.4uH
CHE100W-48S12	--	82u/100V	82u/100V	2200pF	--	--	2200pF	2200pF	2200pF	--	2200pF	--	3.4uH
CHE100W-48S15	--	82u/100V	82u/100V	2200pF	--	--	2200pF	2200pF	2200pF	--	2200pF	--	3.4uH
CHE100W-48S24	--	82u/100V	82u/100V	2200pF	--	--	2200pF	2200pF	2200pF	--	2200pF	--	3.4uH
CHE100W-48S48	--	82u/100V	82u/100V	2200pF	--	--	2200pF	2200pF	2200pF	--	2200pF	--	3.4uH

Note: The C2, C3 are aluminum KY Series capacitors, CY3, CY4, CY5, CY7 are ceramic capacitors.

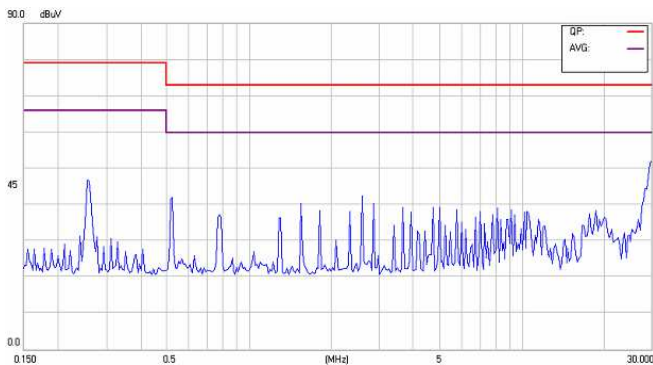

Conducted Class A of CHE100W-24S3V3

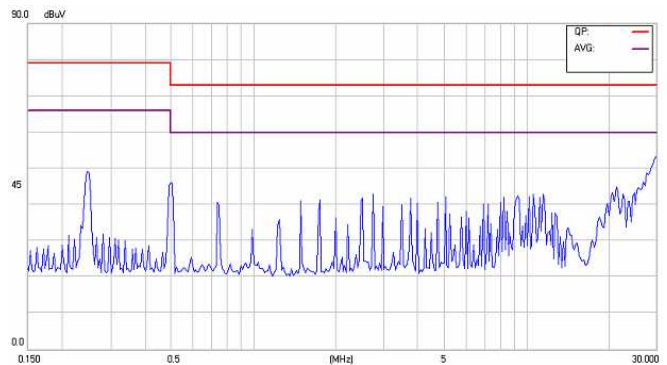

Conducted Class A CHE100W-24S05

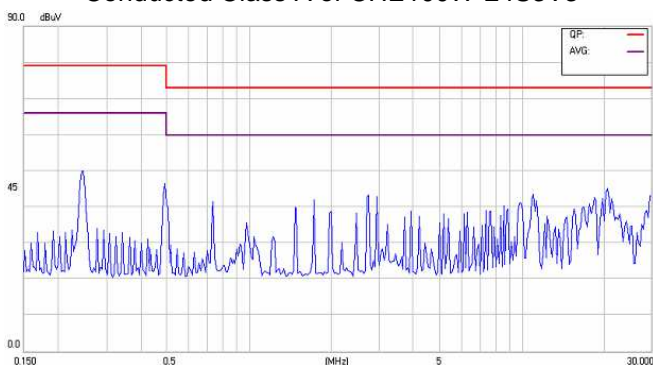

Conducted Class A of CHE100W-24S12

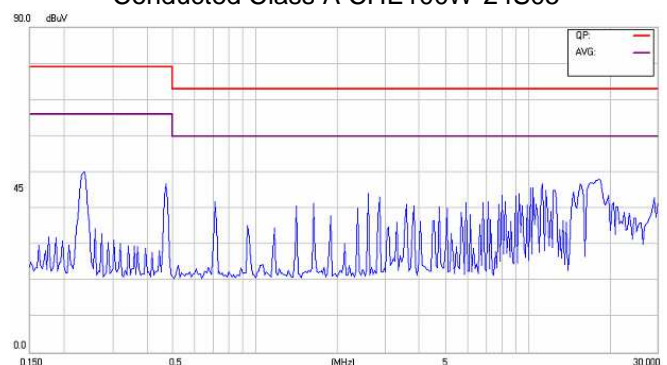

Conducted Class A CHE100W-24S15

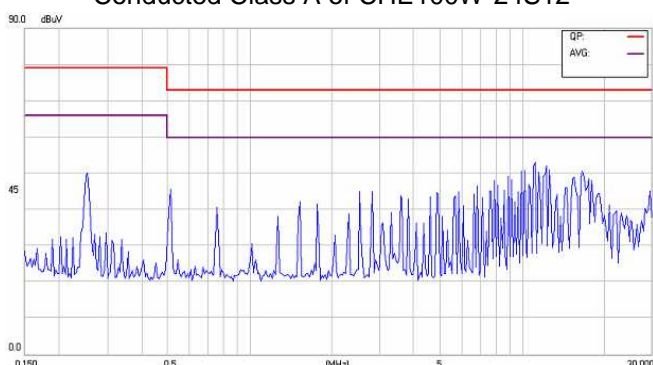

Conducted Class A of CHE100W-24S24

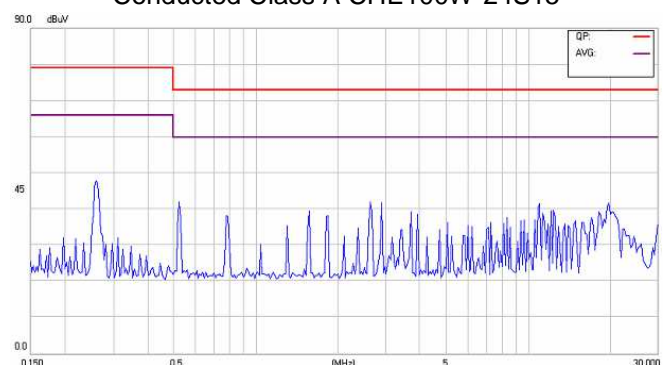

Conducted Class A CHE100W-24S48



# CHE100W Series

## Application Note V10 March 2013

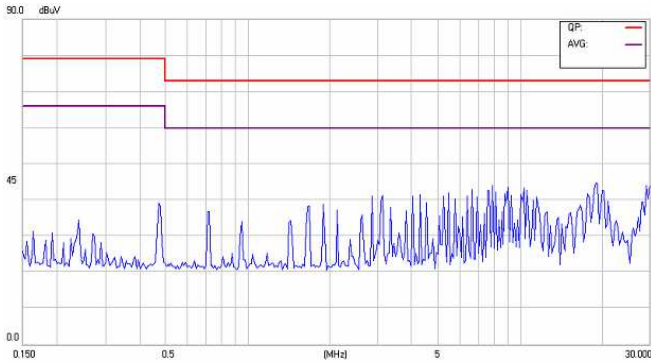

Conducted Class A of CHE100W-48S3V3

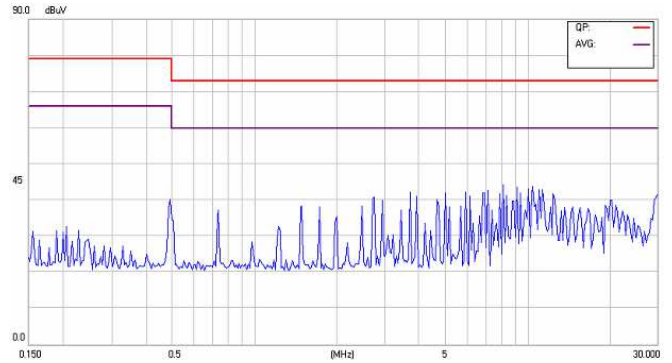

Conducted Class A CHE100W-48S05

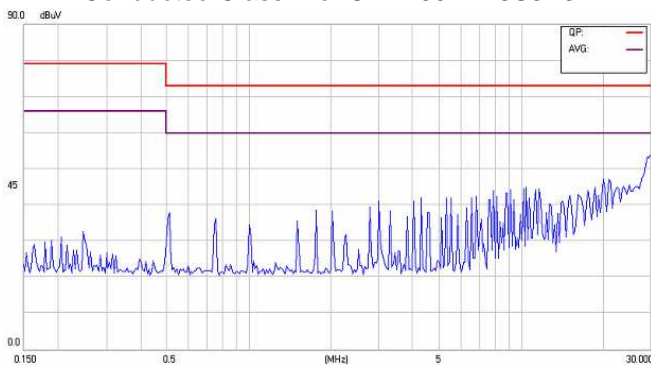

Conducted Class A of CHE100W-48S12

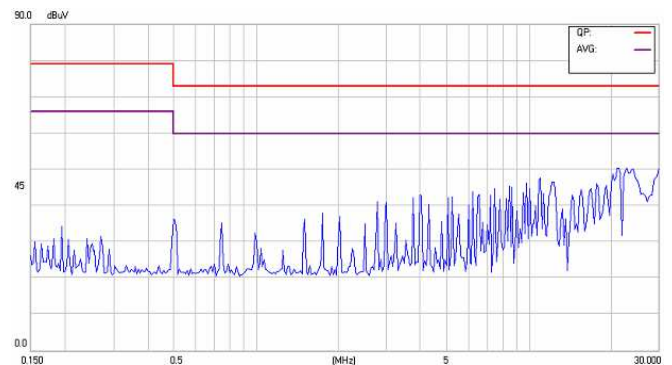

Conducted Class A CHE100W-48S15

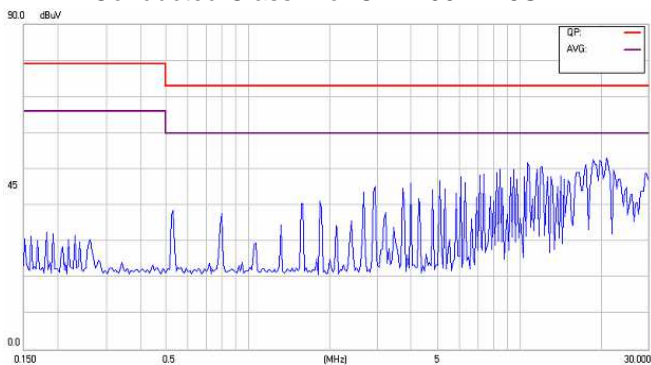

Conducted Class A of CHE100W-48S24

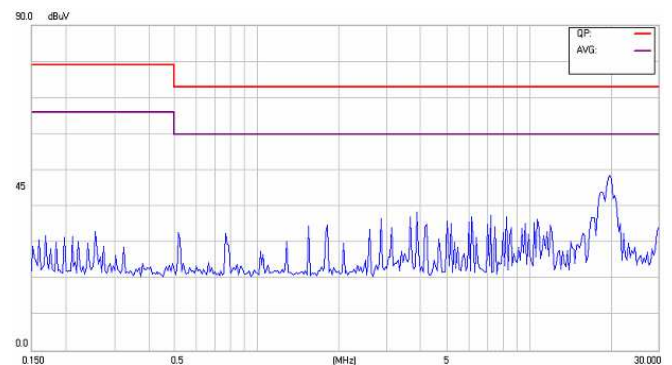

Conducted Class A CHE100W-48S48



# CHE100W Series Application Note V10 March 2013

(2) EMI and conducted noise meet EN55022 Class B:

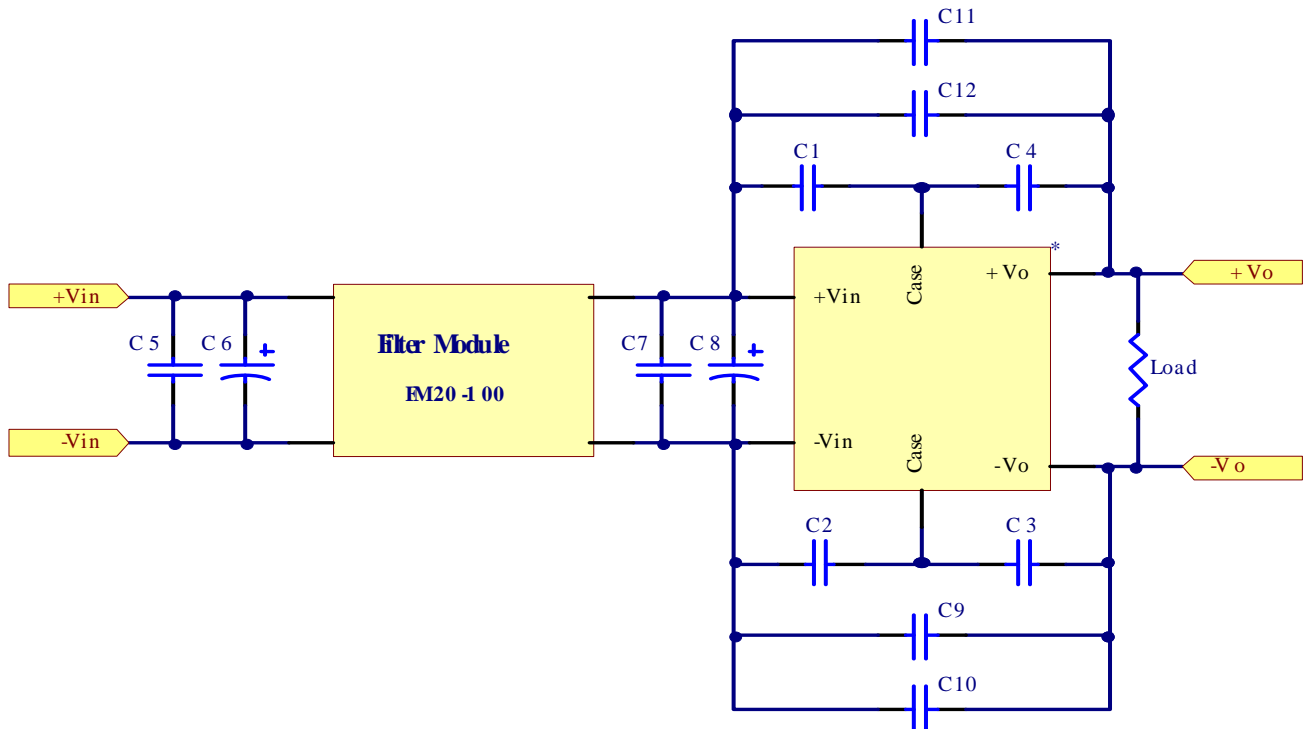

Model No.	C5	C6	Filter Module	C1	C2	C3	C4	C7	C8	C9	C10	C11	C12
CHE100W-24S33	--	330u/63V	FM20-100	--	2200pF	--	--	--	330u/63V	2200pF	--	--	2200pF
CHE100W-24S05	--	330u/63V	FM20-100	--	2200pF	--	--	--	330u/63V	2200pF	--	--	2200pF
CHE100W-24S12	--	330u/63V	FM20-100	--	2200pF	--	--	--	330u/63V	2200pF	--	--	2200pF
CHE100W-24S15	--	330u/63V	FM20-100	--	2200pF	--	--	--	330u/63V	2200pF	--	--	2200pF
CHE100W-24S24	--	330u/63V	FM20-100	--	2200pF	--	--	--	330u/63V	2200pF	--	--	2200pF
CHE100W-24S48	--	330u/63V	FM20-100	--	2200pF	--	--	--	330u/63V	2200pF	--	--	2200pF
CHE100W-48S33	--	82u/100V	FM20-100	--	2200pF	--	--	--	82u/100V	2200pF	2200pF	--	2200pF
CHE100W-48S05	--	82u/100V	FM20-100	--	2200pF	--	--	--	82u/100V	2200pF	2200pF	--	2200pF
CHE100W-48S12	--	82u/100V	FM20-100	--	2200pF	--	--	--	82u/100V	2200pF	2200pF	--	2200pF
CHE100W-48S15	--	82u/100V	FM20-100	--	2200pF	--	--	--	82u/100V	2200pF	2200pF	--	2200pF
CHE100W-48S24	--	82u/100V	FM20-100	--	2200pF	--	--	--	82u/100V	2200pF	2200pF	--	2200pF
CHE100W-48S48	--	82u/100V	FM20-100	--	2200pF	--	--	--	82u/100V	2200pF	2200pF	--	2200pF

Note: The C6, C8 are aluminum KY Series capacitors, C2, C9, C10, C12 are ceramic capacitors.



# CHE100W Series

## Application Note V10 March 2013

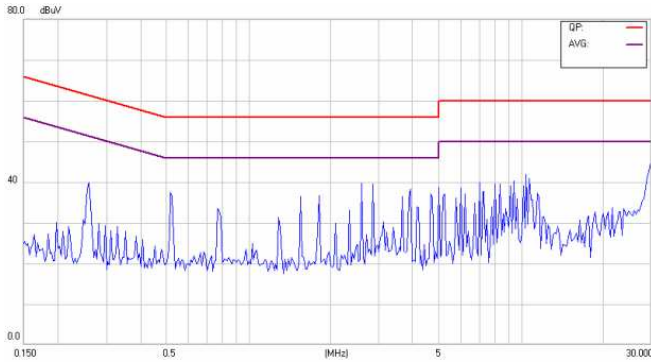

Conducted Class B of CHE100W-24S3V3

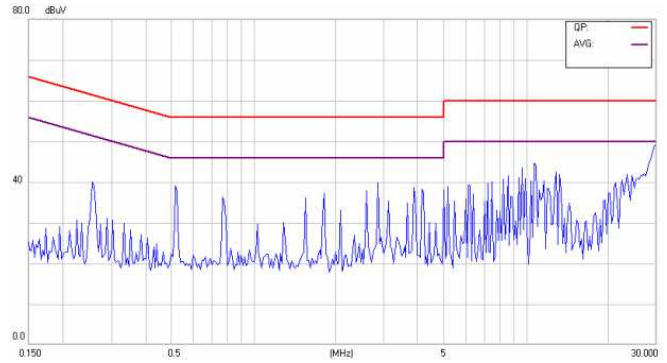

Conducted Class B CHE100W-24S05

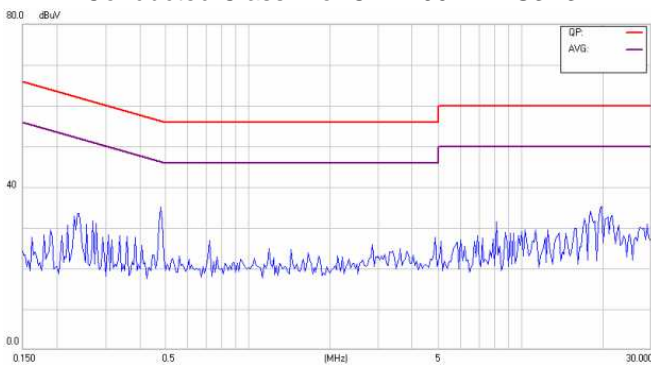

Conducted Class B of CHE100W-24S12

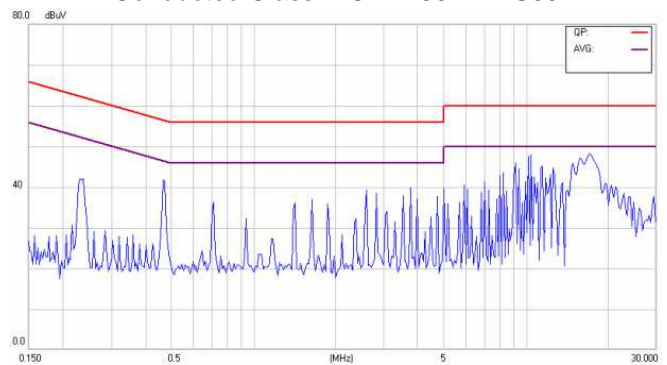

Conducted Class B CHE100W-24S15

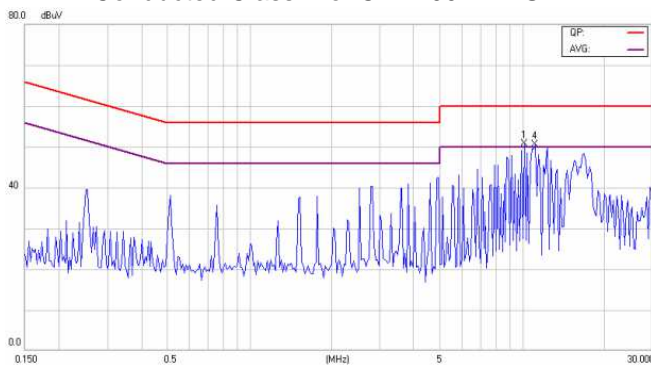

Conducted Class B of CHE100W-24S24

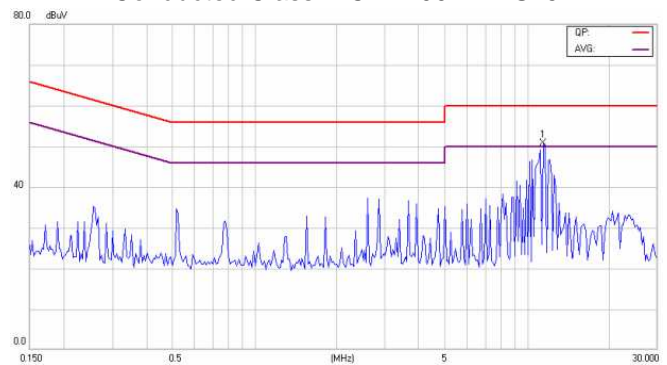

Conducted Class B CHE100W-24S48



Conducted Class B of CHE100W-48S3V3

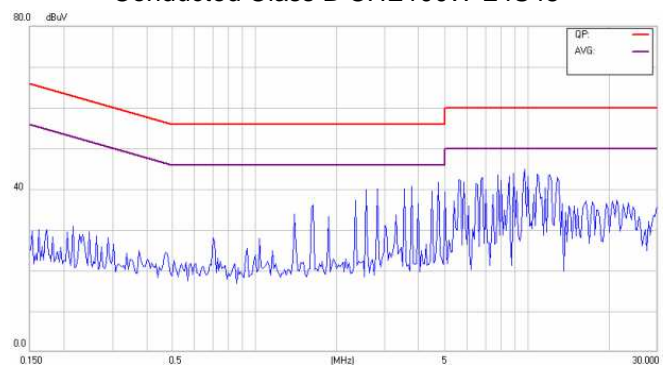

Conducted Class B CHE100W-48S05



# CHE100W Series

## Application Note V10 March 2013

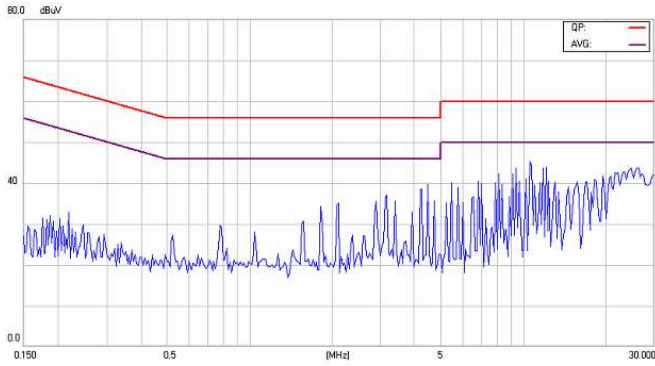

Conducted Class B of CHE100W-48S12

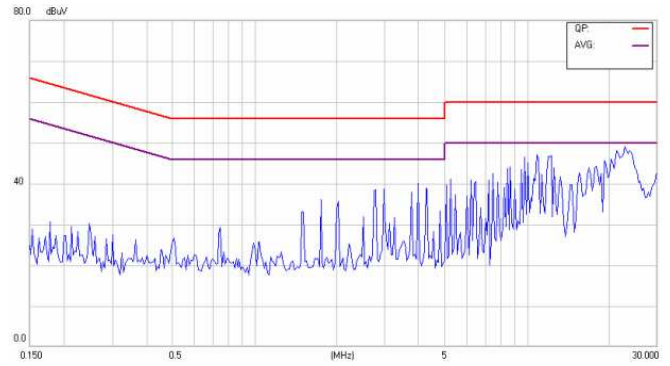

Conducted Class B CHE100W-48S15

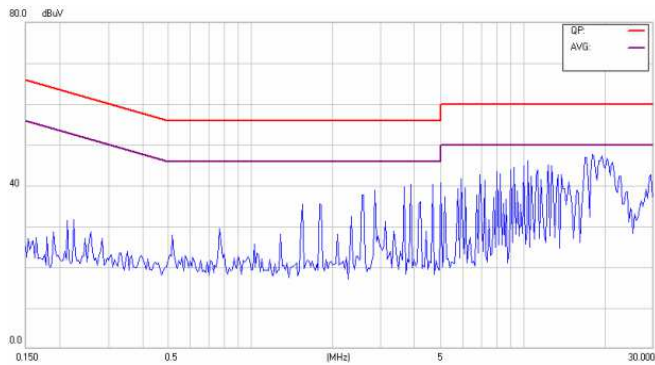

Conducted Class B of CHE100W-48S24

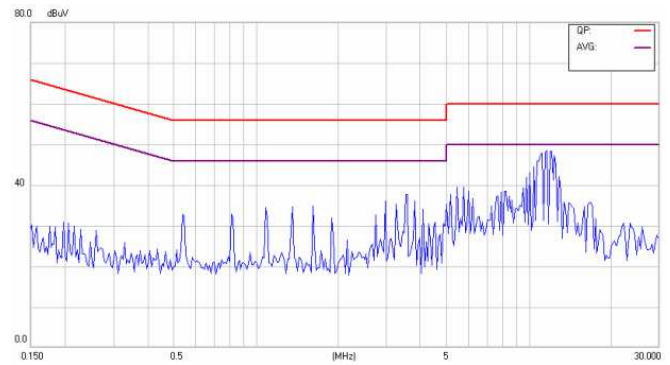

Conducted Class B CHE100W-48S48





# CHE100W Series Application Note V10 March 2013

## 8. Part Number

Format: CHE100W - II X 00 L

Parameter	Series	Nominal Input Voltage	Number of Outputs	Output Voltage	Remote ON/OFF Logic
Symbol	CHE100W	II	X	OO	L
Value	CHE100W	24: 24 Volts 48: 48 Volts	S: Single	3V3: 3.3 Volts 05: 05 Volts 12: 12 Volts 15: 15 Volts 24: 24 Volts 48: 48 Volts	None: Positive N: Negative

## 9. Mechanical Specifications

### 9.1 Mechanical Outline Diagrams

All Dimensions In Inches(mm)

Tolerances Inches: X.XX= ±0.02 , X.XXX= ±0.010

Millimeters: X.X= ±0.5 , X.XX=±0.25

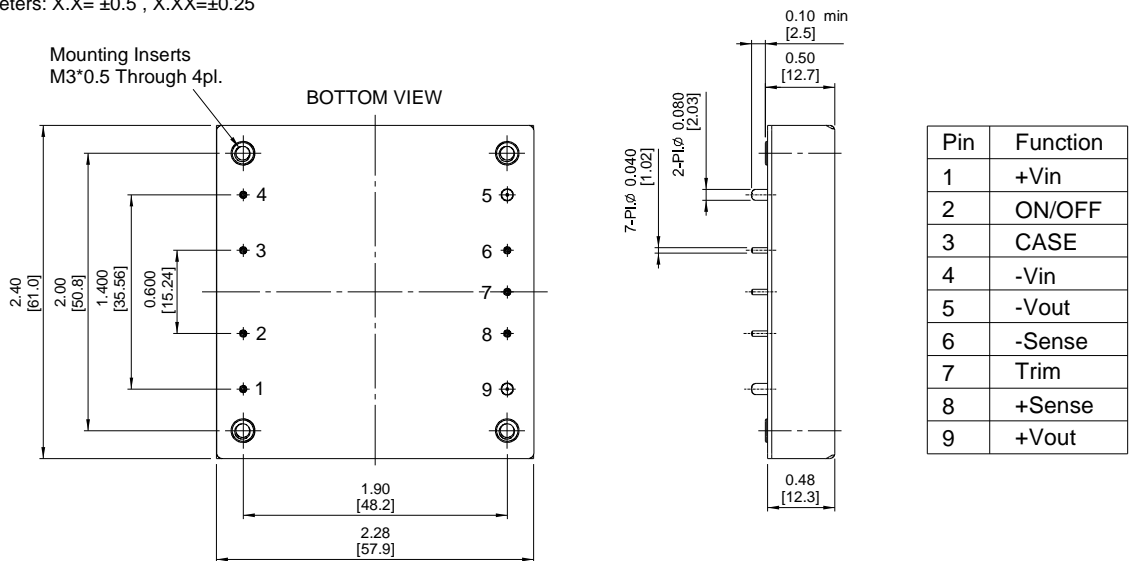

### CINCON ELECTRONICS CO., LTD.

#### Headquarters:

14F, No.306, Sec.4, Hsin Yi Rd.  
Taipei, Taiwan  
Tel: 886-2-27086210  
Fax: 886-2-27029852  
E-mail: [support@cincon.com.tw](mailto:support@cincon.com.tw)  
Web Site: <http://www.cincon.com>

#### Factory:

No. 8-1, Fu Kung Rd.  
Fu Hsing Industrial Park  
Fu Hsing Hsiang,  
Chang Hua Hsien, Taiwan  
Tel: 886-4-7690261  
Fax: 886-4-7698031

#### Cincon North America:

1655 Mesa Verde Ave. Ste 180  
Ventura, CA 93003  
Tel: 805-639-3350  
Fax: 805-639-4101  
E-mail: [info@cincon.com](mailto:info@cincon.com)